

ENGLISH

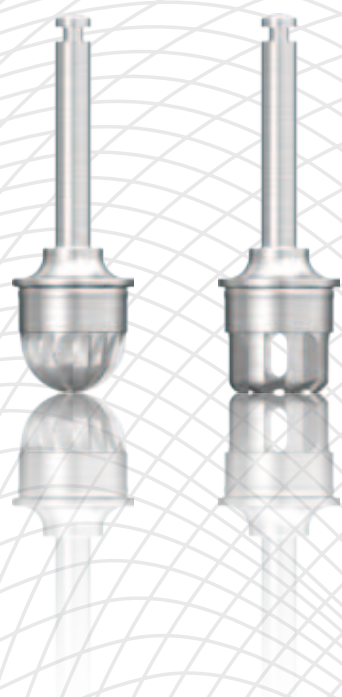
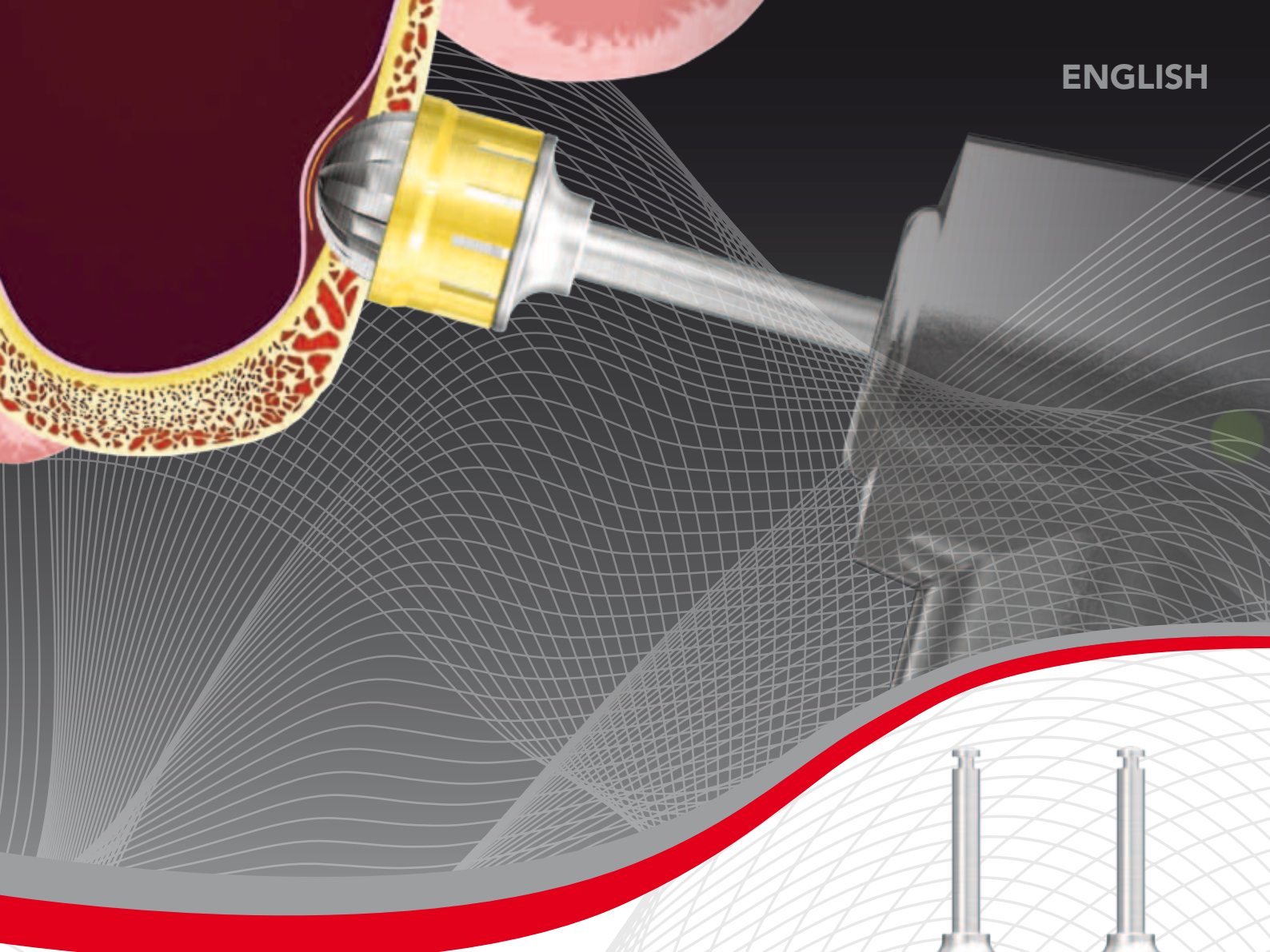

HIOSSEN

OSSTEM[®]

IMPLANT

Qualität schafft Vertrauen

Lateral Approach Sinus-KIT

LAS-KIT

LAS-KIT

(Lateral Approach Sinus - KIT)

Contents

- 1) Introduction
- 2) Features
- 3) Components
- 4) Clinical indication and Case
- 5) Instruction for Use

● Introduction ↙

- Hiossen's Lateral Approach Sinus KIT is specifically designed for a fast and safe lateral approach to lift sinus membrane.

LAS-KIT offers various usage depending on the oral anatomy and surgical plans.

LAS-KIT contains Dome drill to create a lateral window, Wide dome drill to widen the window, Core drill that can create core bone lid.

- Dome and Core Drills to create lateral window.
- Stopper system to prevent excessive and over drilling.
- Dome Drill : Exceptional cutting ability through the combined use of macro and micro blades.
- Core Drill : continued successful design concept of CAS-Drills
- Wide dome drill and side wall drill to enlarge the window



Dome & Core drill



Stopper system

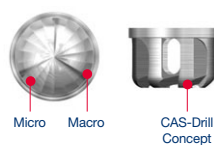

Maximized cutting efficiency



Side window expansion

LAS-KIT (Lateral Approach Sinus - KIT)

Hiossen's Lateral Approach Sinus Kit is specifically designed for a fast and safe approach to lateral sinus lifts.

● Features

- Dome and Core Drills provide ideal approaches to the opening of the lateral wall.

<Dome drill>

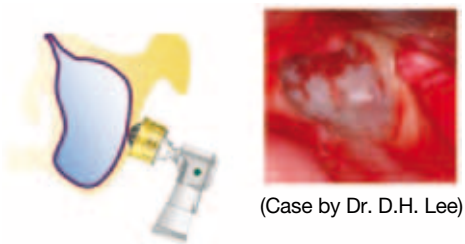

<Core drill>

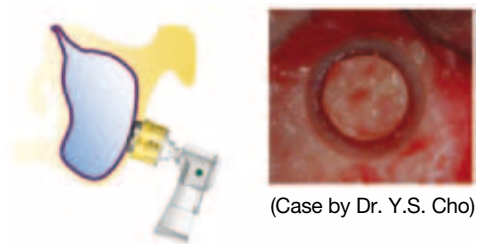

- Excellent cutting ability of the Dome and Core Drills

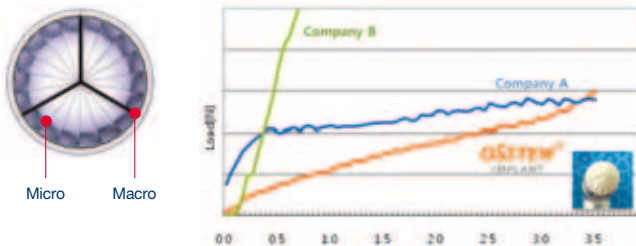

Combination of macro and micro blades offer excellent cutting ability

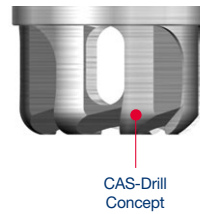

The blade design of LAS-Drill follows the successful design concept of CAS-Drill (Crestal Approach Sinus KIT)

- Wide Dome Drill and Side Wall Drill used to enlarge the window



- Widen the window with Side Wall Drill

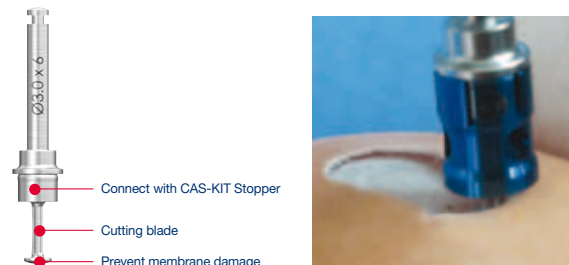

- Hiossen's unique stopper system for depth control. (a total of 6 stoppers : 0.5 / 1.0 / 1.5 / 2.0 / 2.5 / 3.0mm)



LAS-KIT comes with Dome Drill and Core Drill that provide various approaches to a fast and safe lift of sinus membrane.

● Safe Elevation of Sinus Membrane

<Dome drill>

- Minimizing direct contact with the membrane by forming a bone lid



- Formation of bone particles between the cutting blades



- Effective depth control by stopper system (0.5mm increment)
- Stopper can prevent soft tissue damage



<Core drill>

- Round-shaped cutting edge minimizes direct contact with the membrane



- Formation of bone particles between the cutting blades



- Effective depth control by stopper system (0.5mm increment)
- Stopper can prevent soft tissue damage

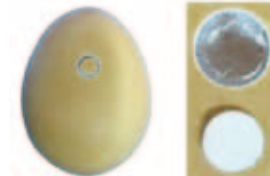

● Ease of Use

<Dome drill>

- The blade head can be perpendicular to the bone to perform an osteotomy.



<Core drill>

- For limited space at surgical site, Dome Drill can be tilted to drill.



● Components

- Dome drill $\varnothing 5.5/\varnothing 7.0$ & Wide dome drill $\varnothing 7.0$, Core drill $\varnothing 5.5/\varnothing 7.0$, Side wall drill, Bone separator, Stopper 0.5 / 1.0 / 1.5 / 2.0 / 2.5 / 3.0
- * Sinus KIT sold separately.

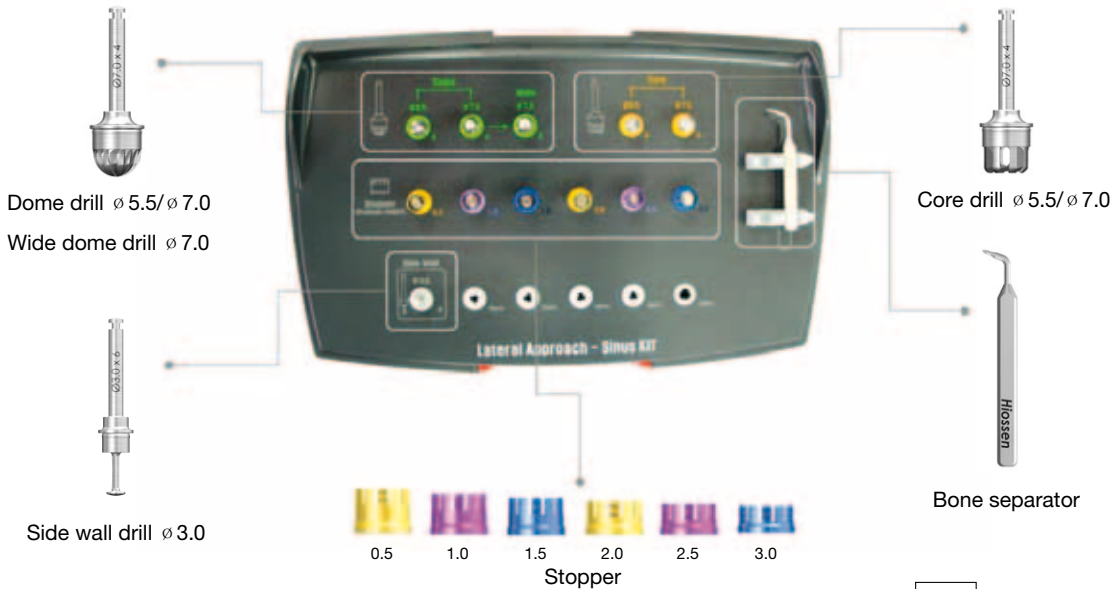

REF Catalog No. : HLRSNK

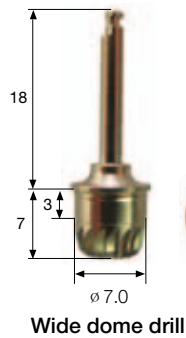
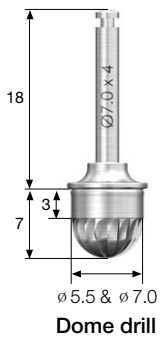

• Dome Drill

- Creates window while collecting autogenous bone
- Macro and Micro cutting blades offer excellent cutting
- Cutting Speed : 1,200 ~ 1,500 RPM
- Drilling depth controlled with stopper system

• Wide dome drill

- Used to widen the window after using Dome drill
- Excellent side cutting ability
- Drilling depth controlled with stopper system
- Cutting Speed : 1,200 ~ 1,500 RPM

* Caution : Over drilling may cause membrane perforation.

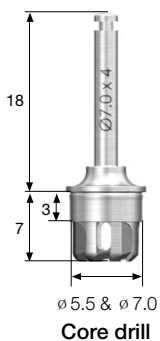

• Core drill

- Creates window while creating bone lid to minimize direct contact
- Drill design follows the successful design concept of CAS-Drills
- Cutting Speed : 1,200 ~ 1,500 RPM
- Drilling depth controlled with stopper system

* Caution : Over drilling may cause membrane perforation.

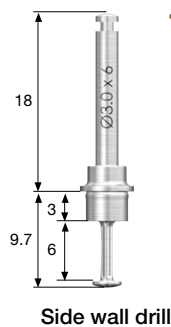

• Side wall drill

- Enlarges the window after using Dome drill
- Cutting Speed : 1,500 RPM
- Recommended to use cutting edge 1mm from the bottom.

• Can be used with CAS-KIT stoppers.

CAS-KIT Stopper(mm)	Lateral Wall Height (H:mm)	Side wall drill + CAS-KIT Stopper
12	5	
11	4	
10	3	
9	2	
8	1	

● Clinical indication and Case

1) Dome drill, Side wall drill for widening the window

by Dr. D.H. Lee

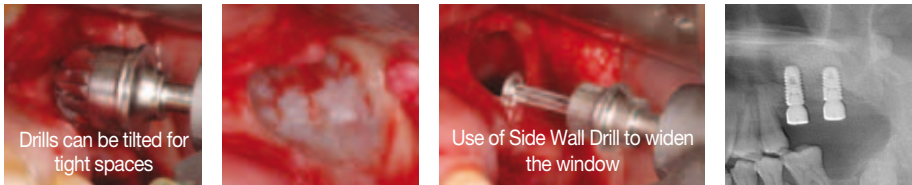

2) Dome drill with stopper

by Dr.Y.S. Cho

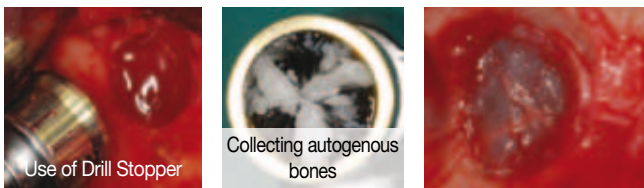

3) Overlapped drilling to create enlarged window

by Dr.Y.S. Cho

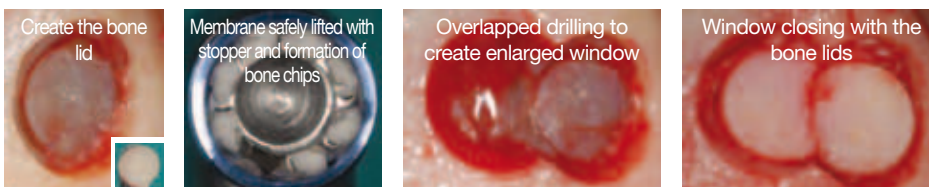

4) Overlapped drilling to create enlarged window

by Dr. D.H. Lee

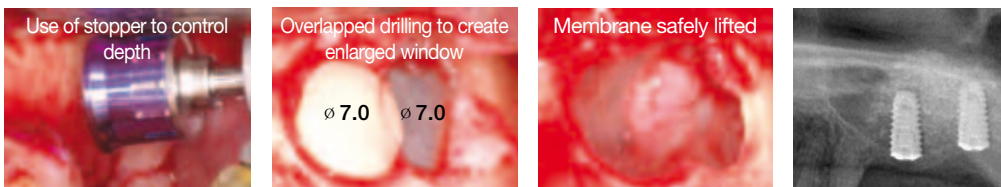

5) Overlapped drilling to create enlarged window with two different drill sizes

by Prof. J.C. Jeong

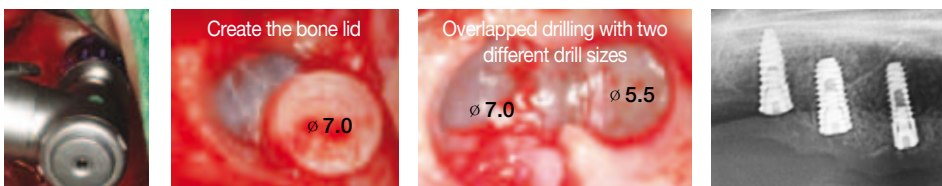

6) Combined use of Core Drill and CAS-Drill

by Dr. M.S. Kim

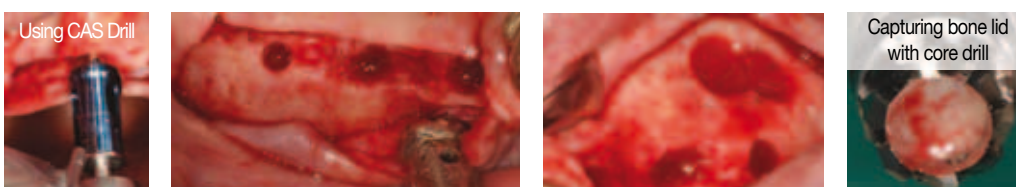

7) Combined use of Core Drill and Hydraulic Lifter from CAS-KIT

by Dr. K.D. Jeong



● LAS-KIT Care & Maintenance ↙

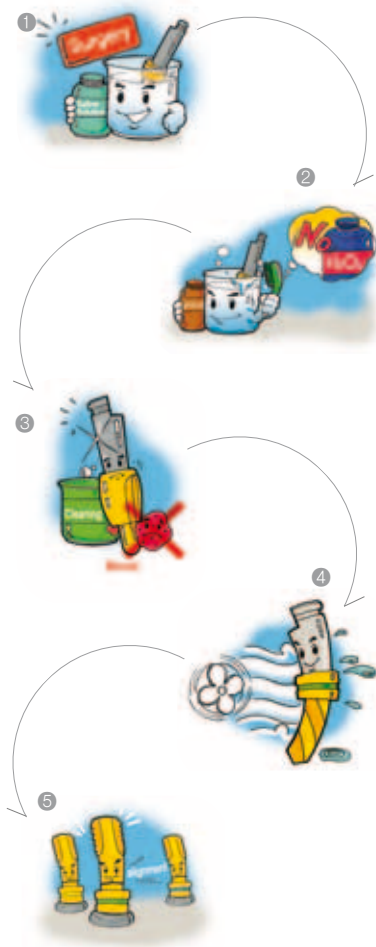

① Prepare tools for surgery by soaking them in a “saline solution” or in “distilled water.”

② After surgery : All tools should be soaked in an “alcohol solution”.

- Caution**
- Avoid using Hydrogen Peroxide.
 - Hydrogen Peroxide will discolor laser markings and anodized surfaces.

③ Tools should be cleaned thoroughly with distilled or tap water to wash away any remaining blood and foreign material.

④ Completely dry all tools using a dry cloth or warm air.

⑤ Dried tools should be stored in the KIT case.
(Please refer to the color coding when placing the tools back in the case)

⑥ After placing all the tools back into the KIT, dry the entire KIT in an Autoclave (132°C for 15 minutes) and then store the KIT at room temperature.

NOTES:

It is recommended to re-sterilize the surgical KIT right before surgery. (132°C; for 15 minutes)

Immediately after surgery, all the tools should be cleaned and stored.

The LAS-KIT has a one year warranty on all parts & case.

The recommended usage of the drills is 50 times.

Lateral Approach Sinus-KIT LAS-KIT

Edition 02/2013 EN
www.sinuskit.com
www.osstem.de

HIOSSSEN

Manufacturer
HIOSSSEN Inc.

85 Ben Fairless Dr
Fairless Hills, PA 19030, USA
TEL: 1-888-678-0001
FAX: 1-267-759-7004
www.hiossen.com

OSSTEM[®]
IMPLANT

Qualität schafft Vertrauen

Authorized Sales by
OSSTEM Germany GmbH

Mergenthalerallee 25
65760 Eschborn, Germany
Tel.: +49 (0) 6196 777 550
Fax: +49 (0) 6196 777 5529

www.osstem.de • germany@osstem.de